

60 LO-2100

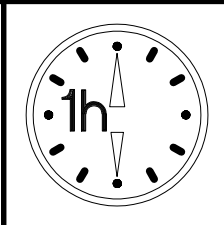

Ersatzteil Nummer	Dimension
KUH.10301	2095x550x16
KUH.10302	2095x550x16
KUH.30002	566x430x16
KUH.40007	567x485x16
KUH.40008	567x485x16
KUH.40142 x2	567x485x16
KUH.60265	200x585x2,5
KUH.60130	393x585x2,5
KUH.60221	721x585x2,5
KUH.70985	596x1280x16
KUH.70604	596x140x16
KUH.70605	596x570x16
KUH.90015	599x95x16

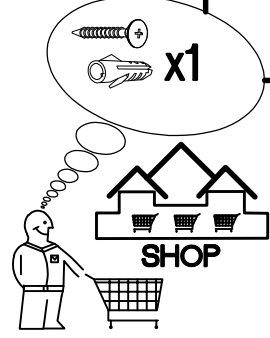
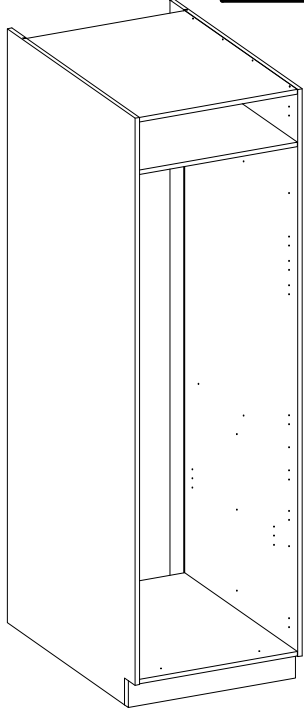
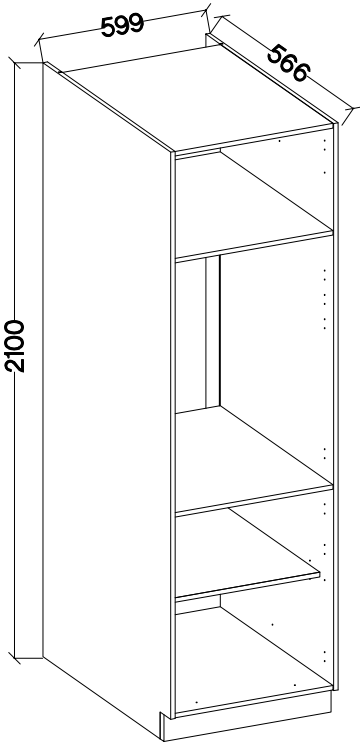
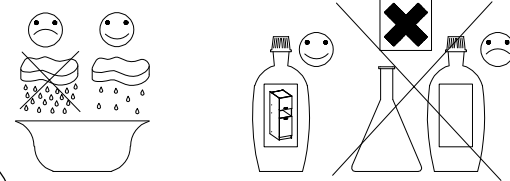
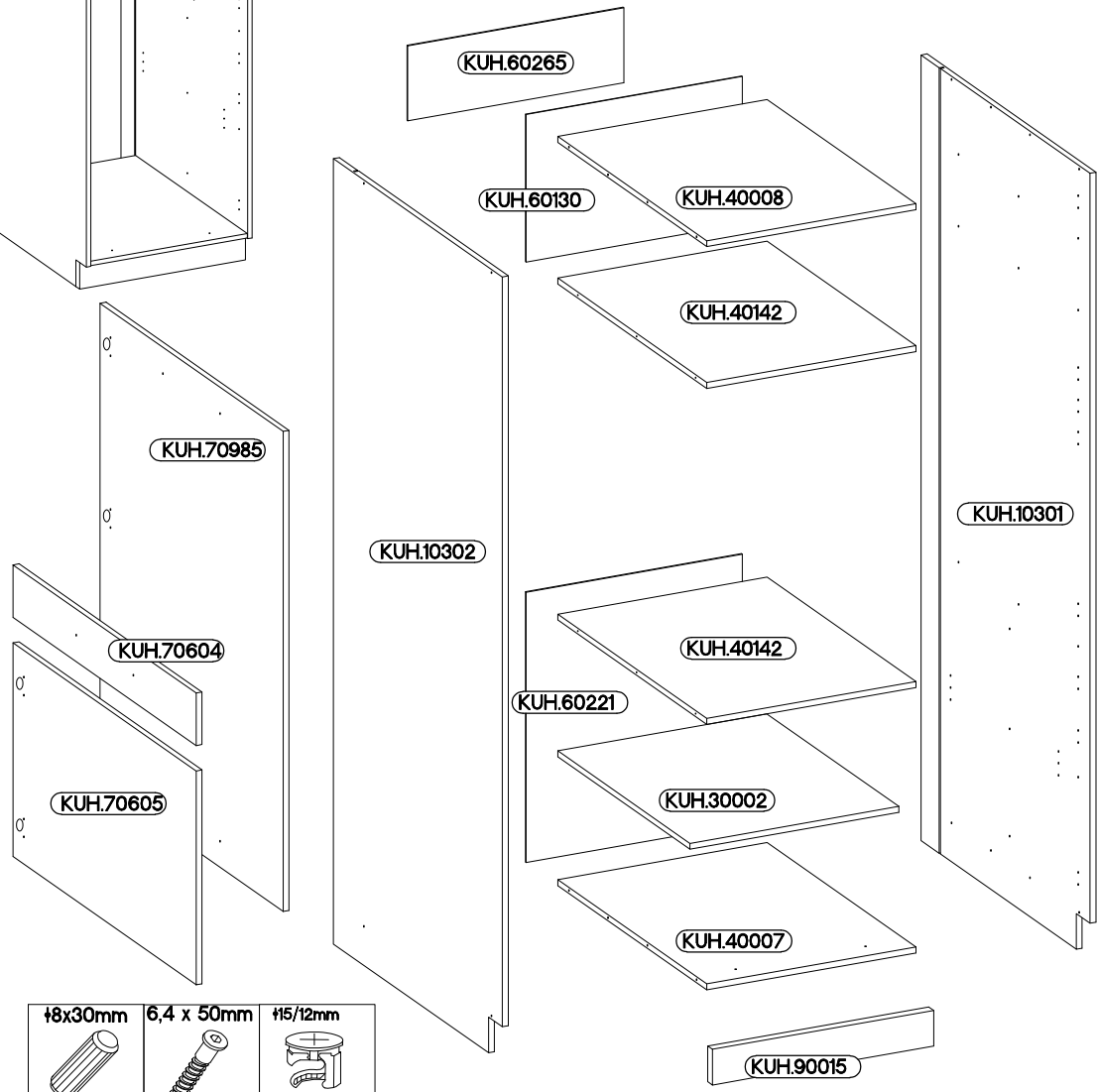

†8x30mm	6,4 x 50mm	†15/12mm
A	B	C

L=20mm 								
12	12	8	2	4	5	4	2	1
		†4.0x16mm 	†4.0x45mm 	†3.5x13mm 	†3.0x20mm 	L=192mm 	M4x22mm 	
1	1	16	2	16	15-20	2	4	4

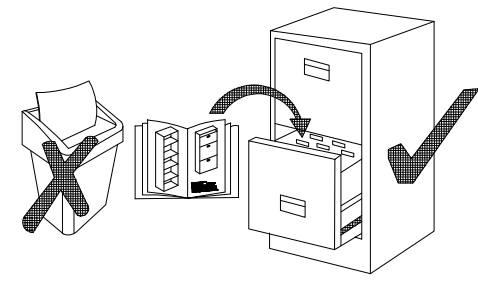

WARIANT A

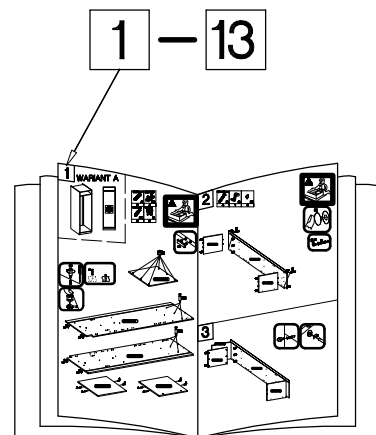
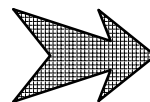
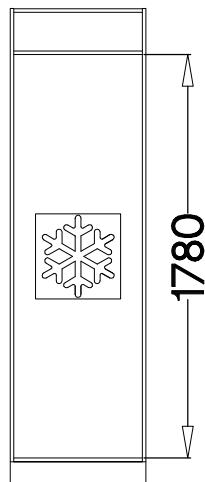
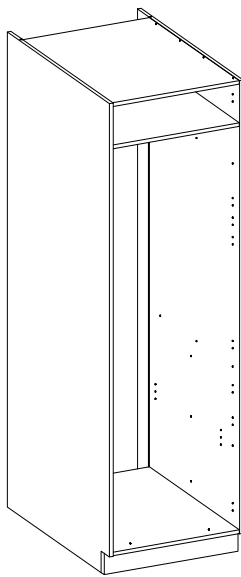
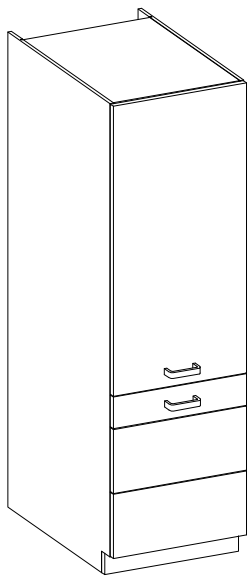

WARIANT B

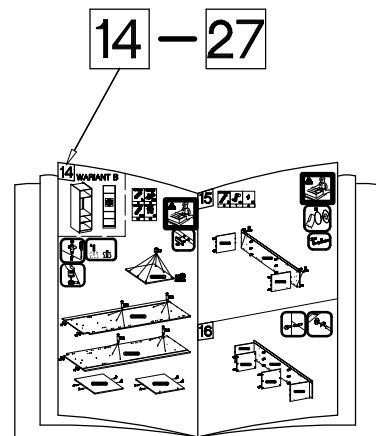
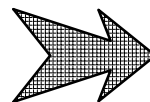
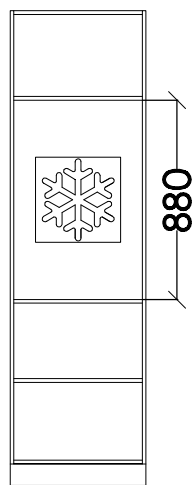
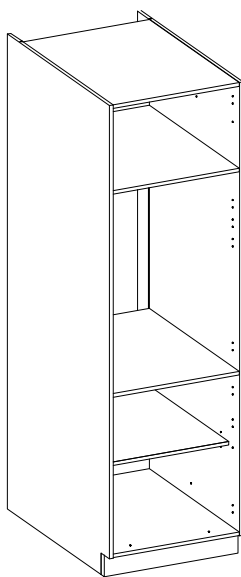
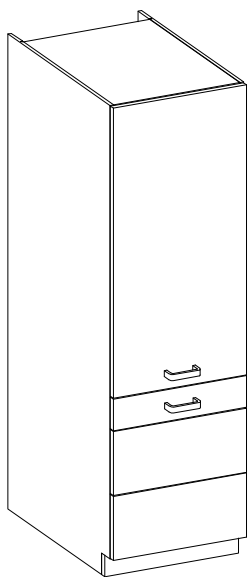

1

WARIANT A

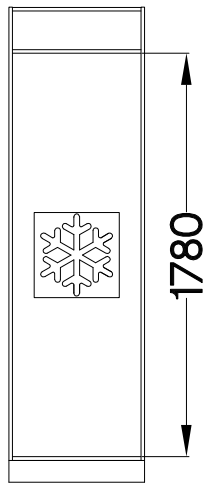
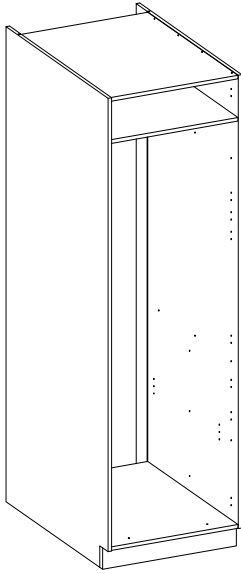

∅8x30mm



A

6.5x48x16

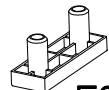

F2

8



L=20mm

D2

6

∅15/12mm



C

6

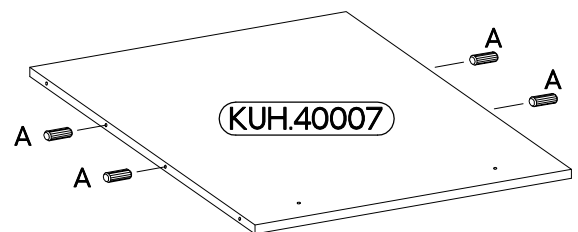
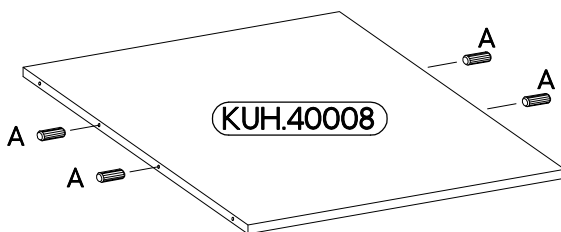
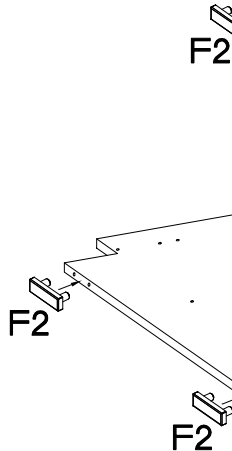
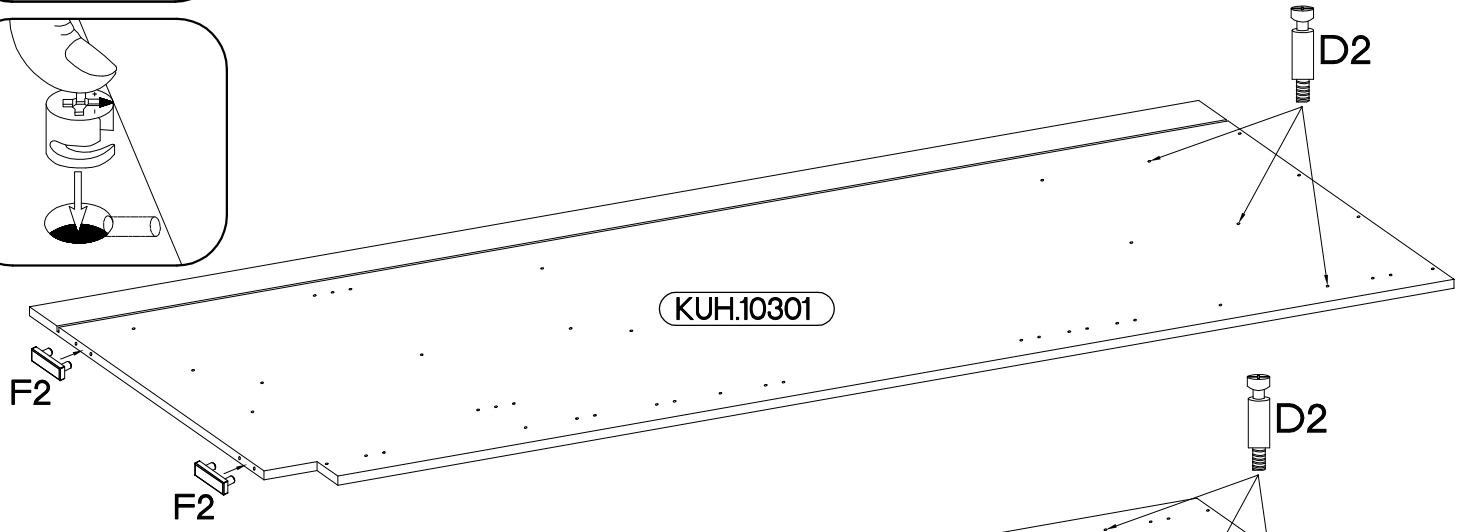
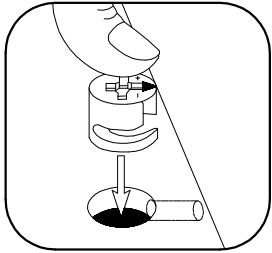
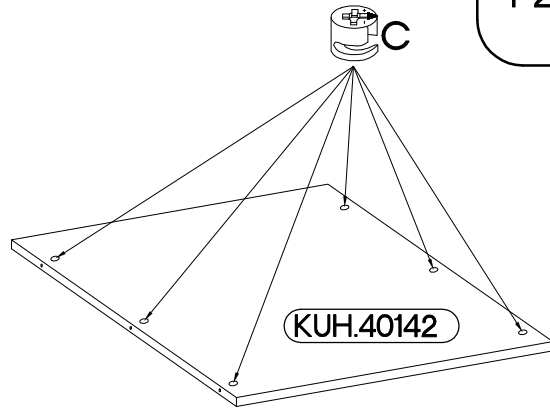
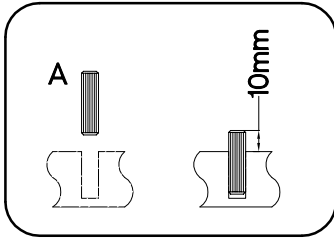
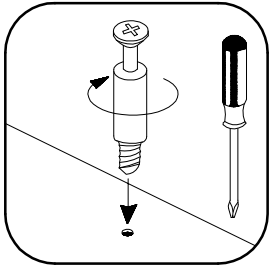
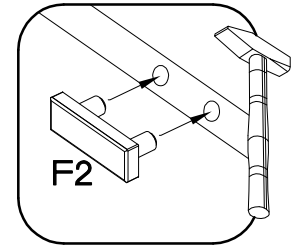
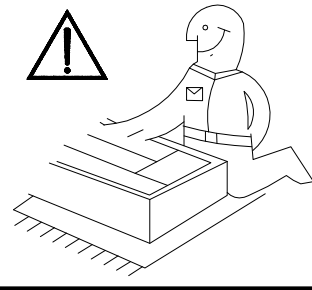

2

6,4 x 50mm

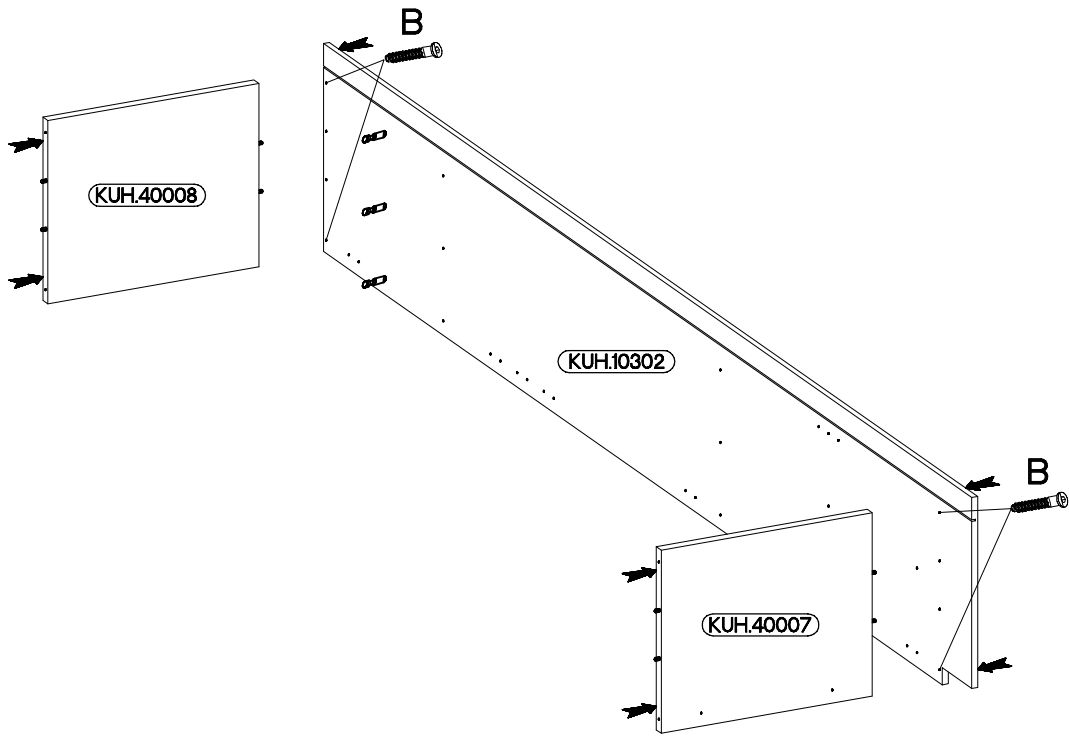
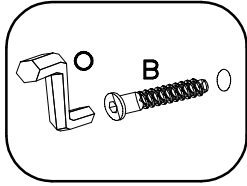
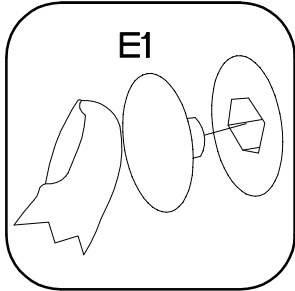
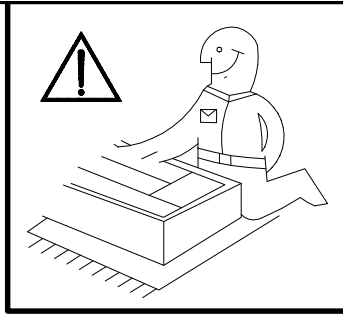
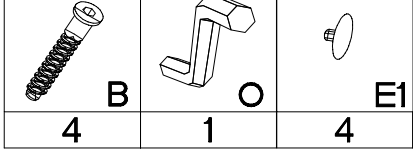

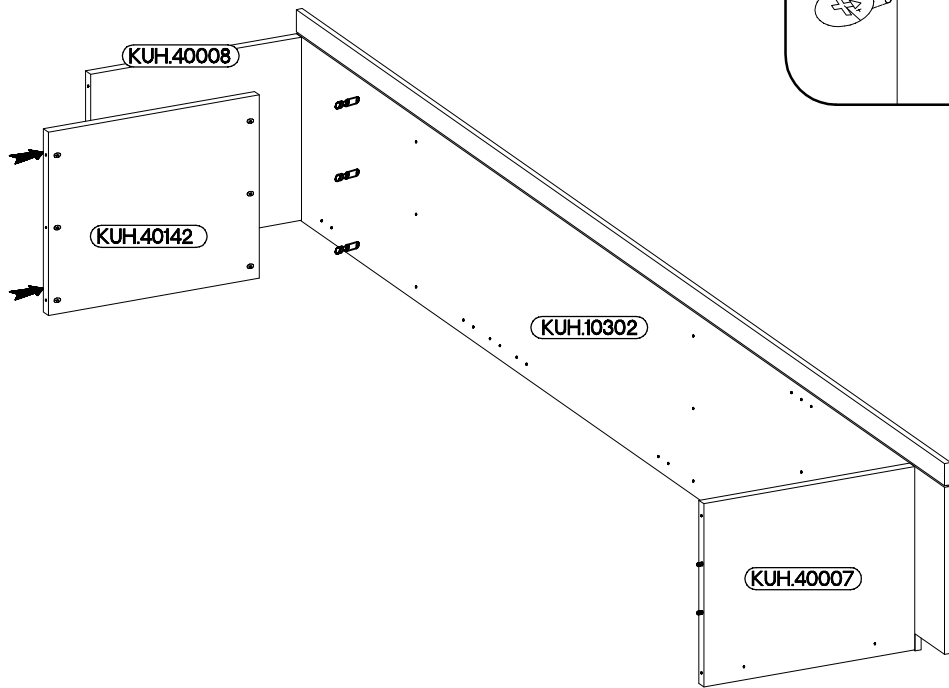
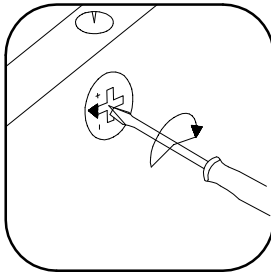
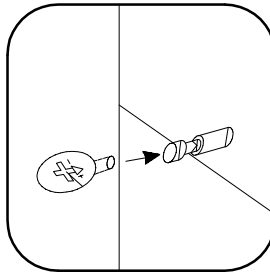

3



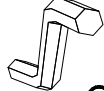

4

6,4 x 50mm

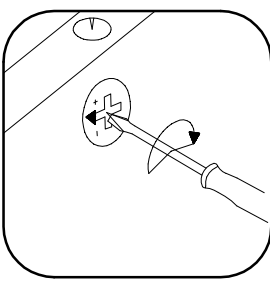
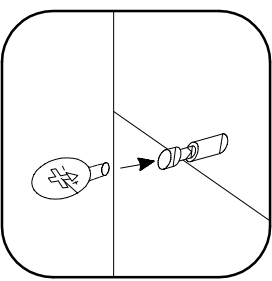
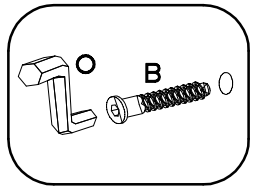
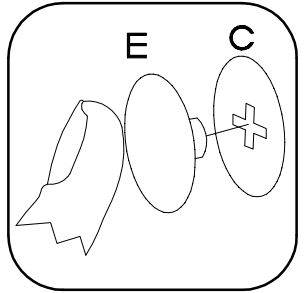
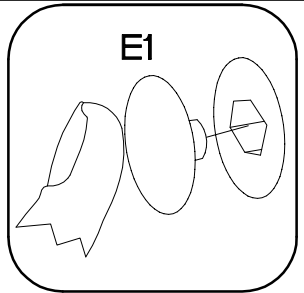
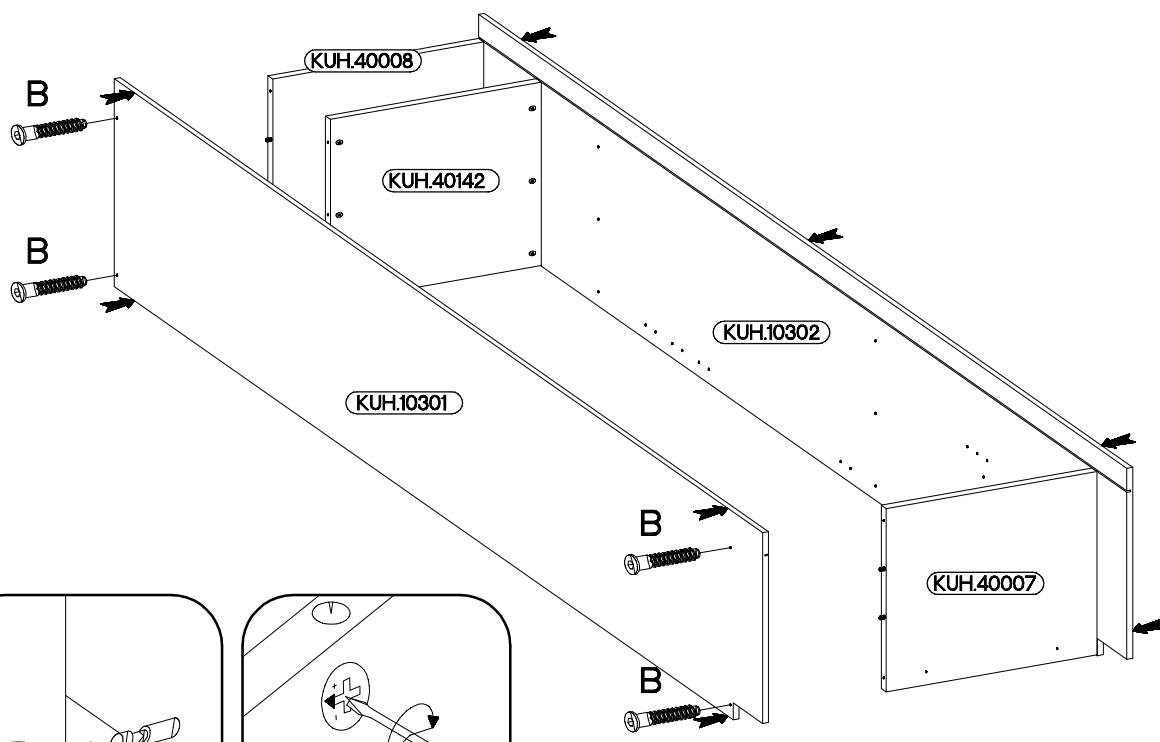
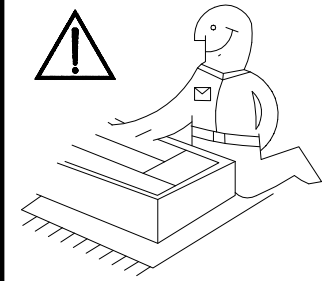
			
B	O	E1	E
4	1	4	6

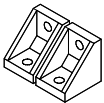

5

	
T4	P1
4	16

4.0x16mm

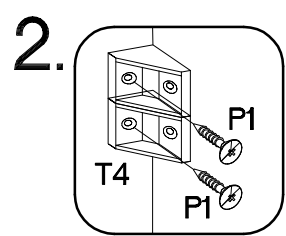
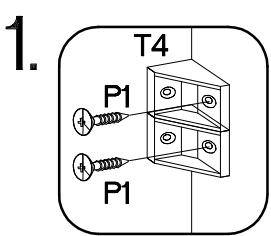
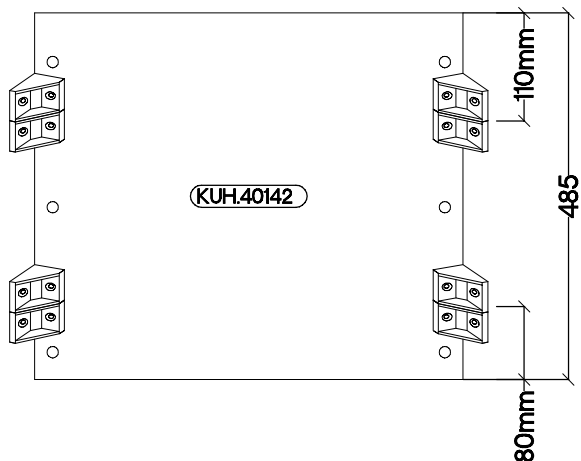
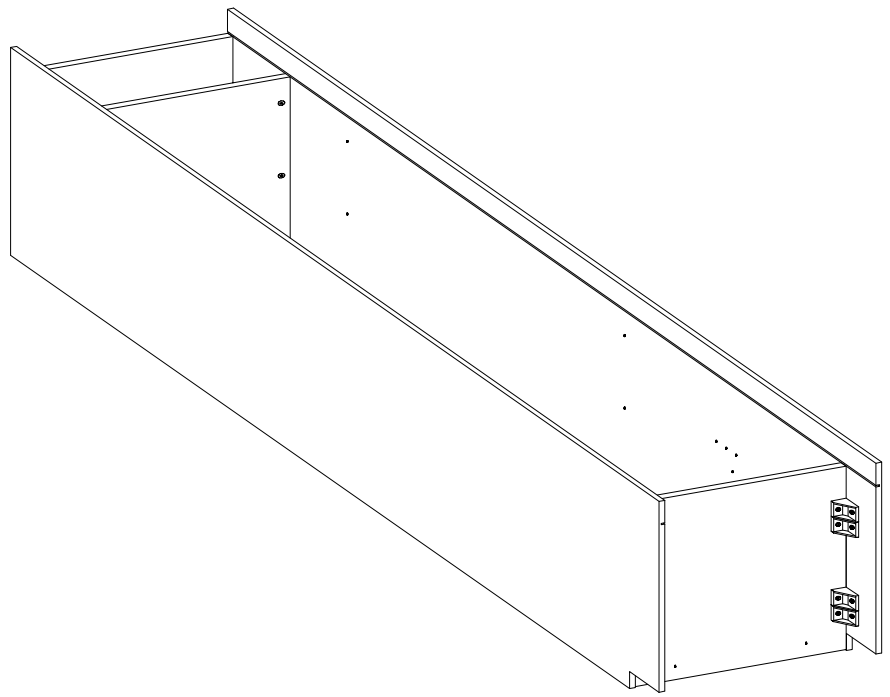

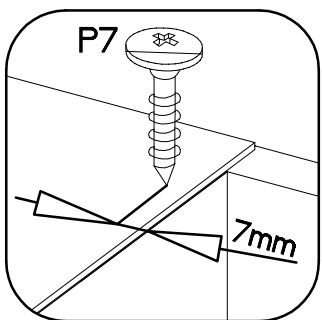
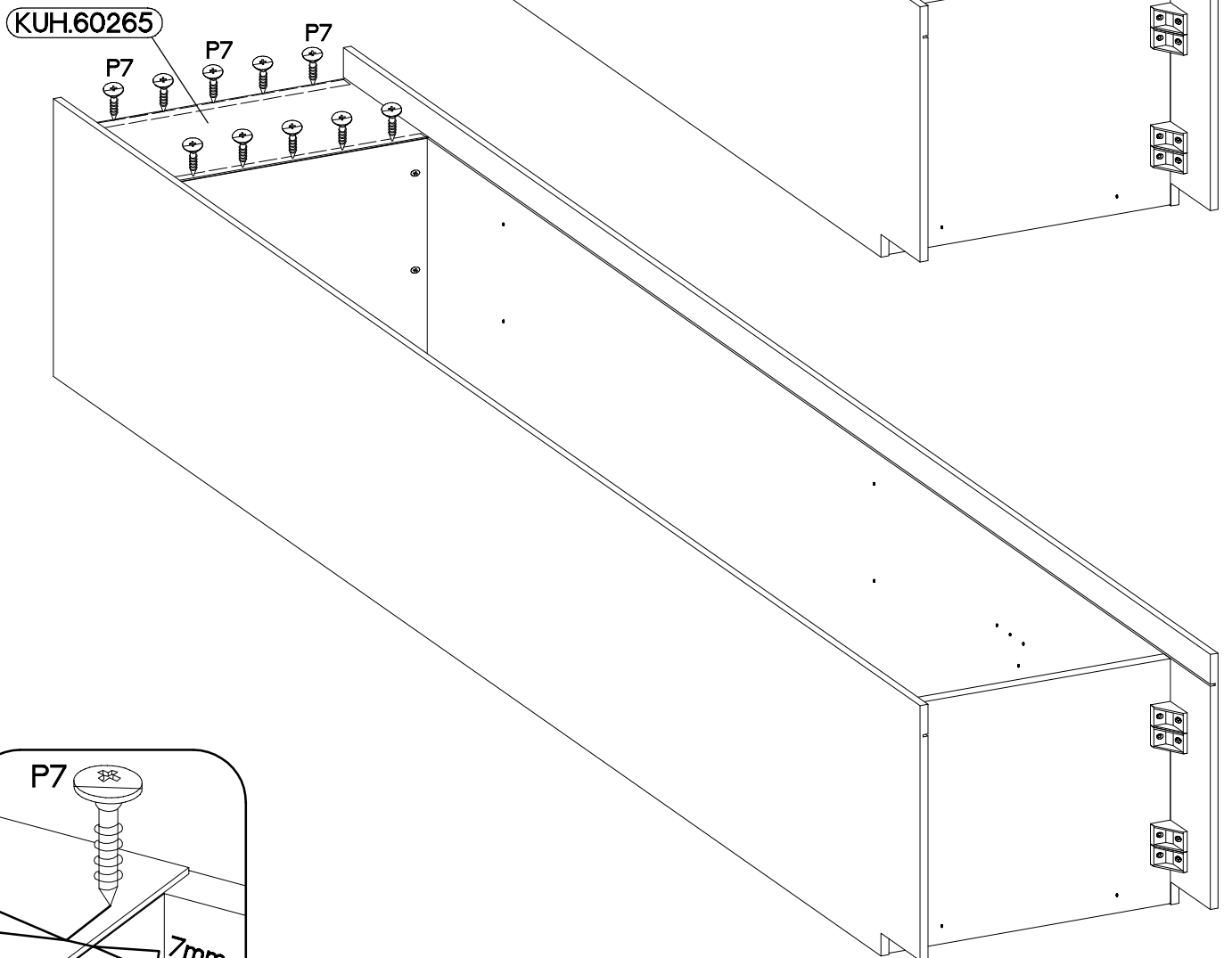
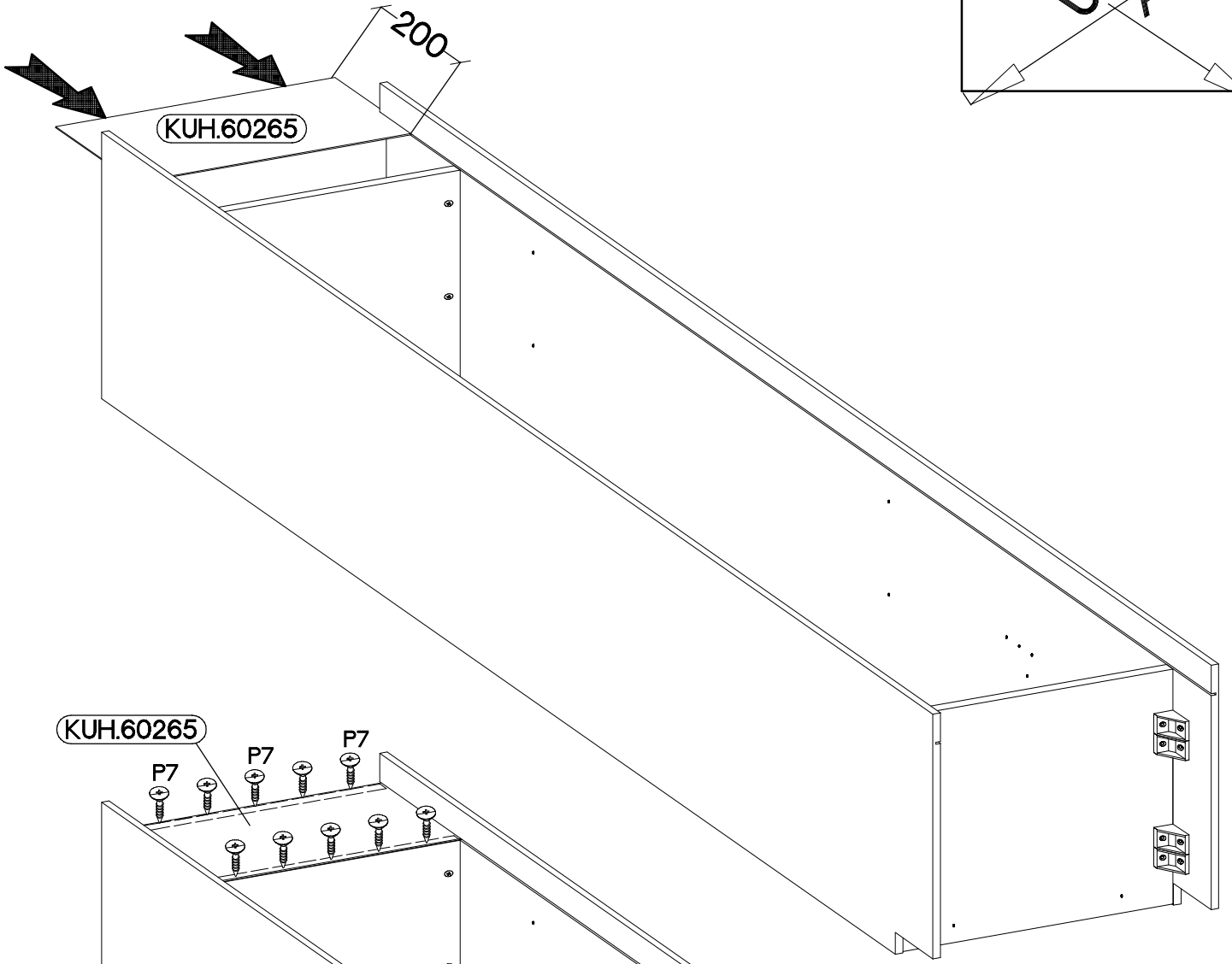
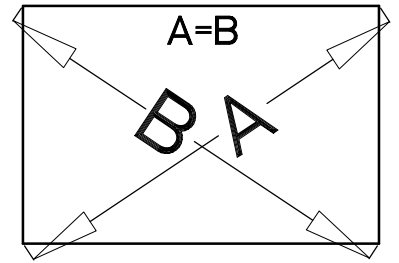

6

φ3.0x20mm
P7
8-10



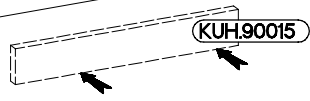
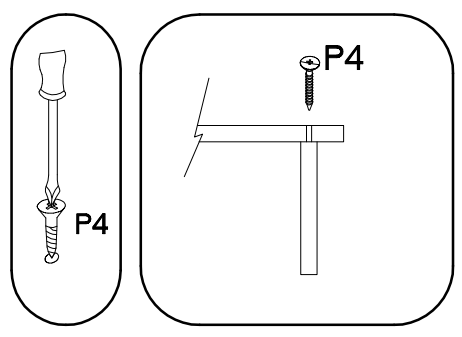
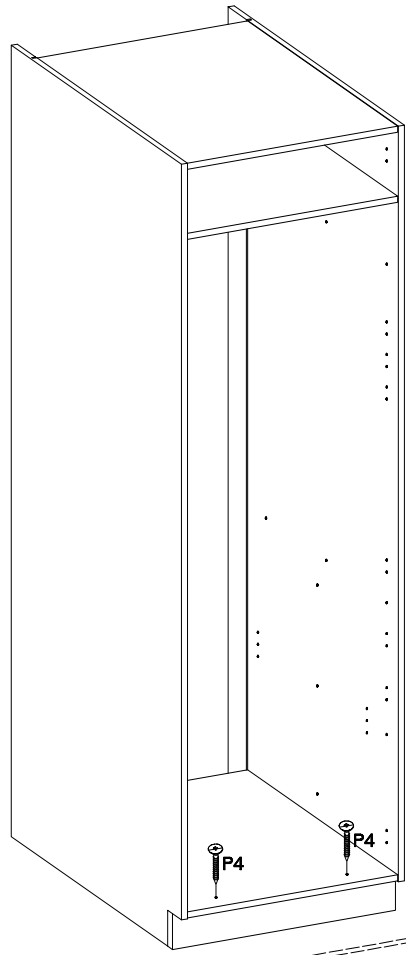

7

$\pm 4.0 \times 45 \text{mm}$  P4 2	 E9 2
--	---

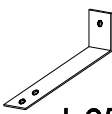

8

 L25 1	$\pm 3.5 \times 13 \text{mm}$  P5 2
---	---

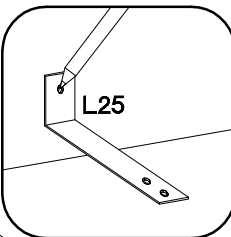
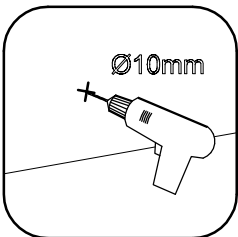
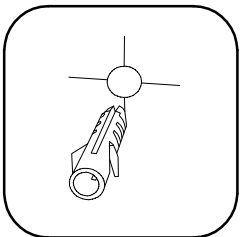
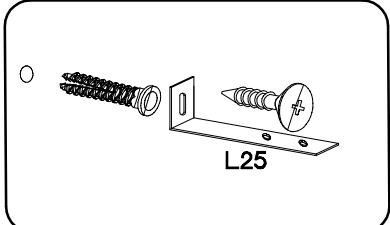
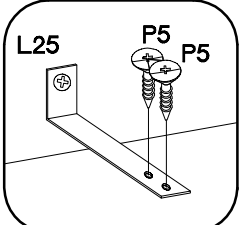

- 
- 
- 
- 
- 

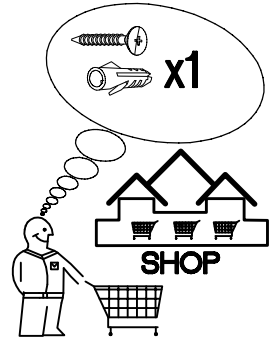
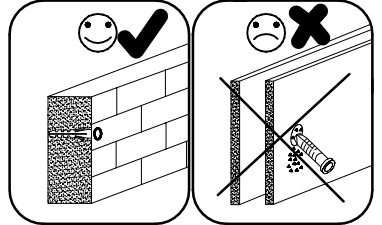

9

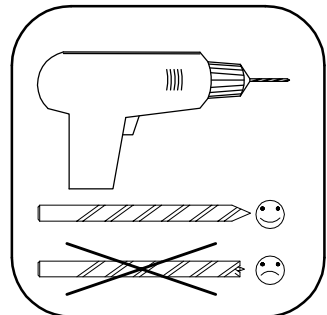
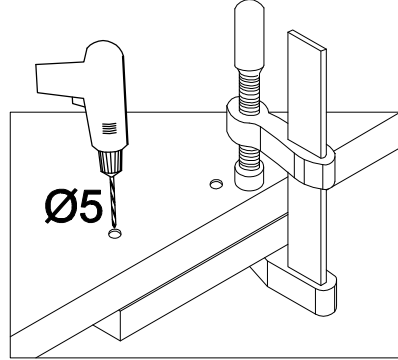
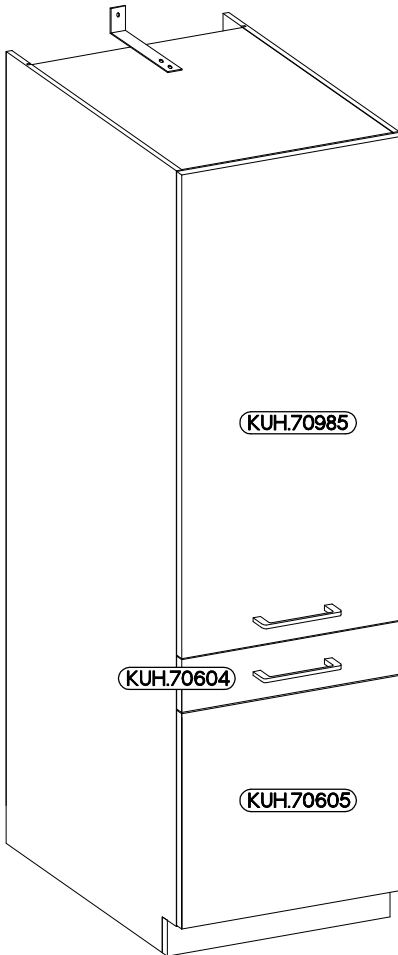

LEFT

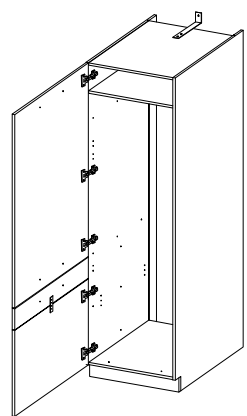

RIGHT

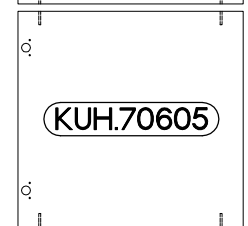
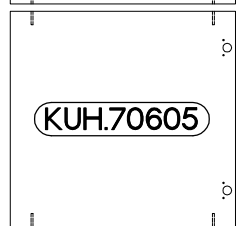
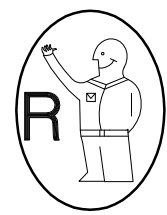
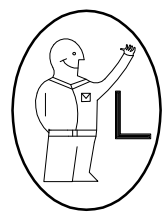
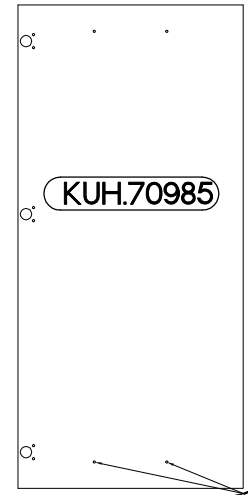
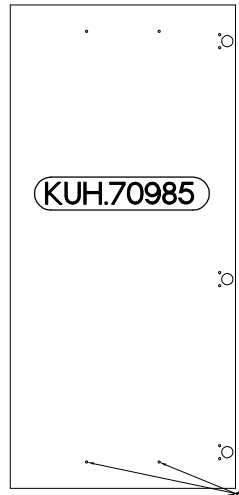
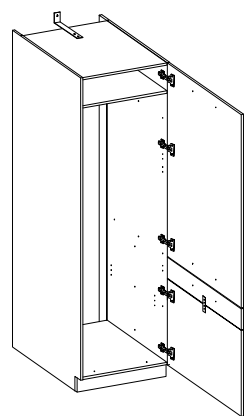

10

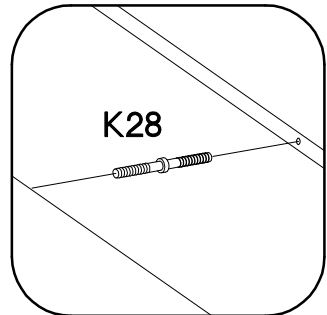
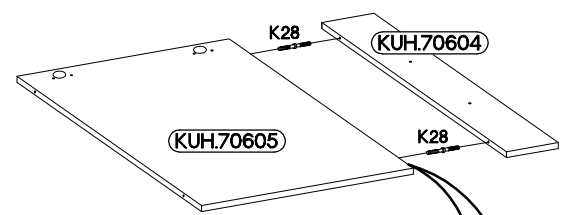
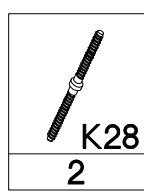

VARIANT HIGH GLOSS

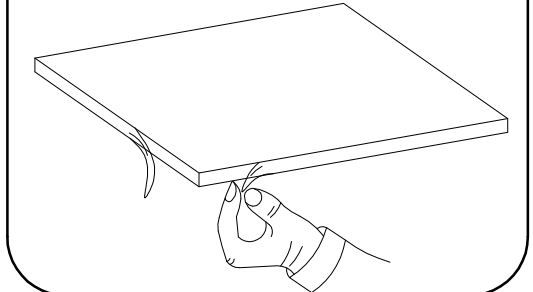

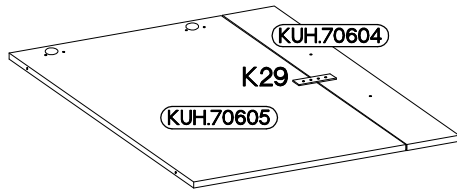
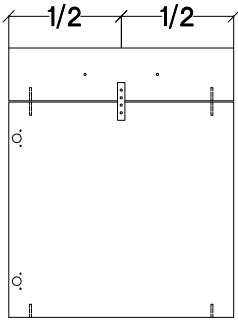
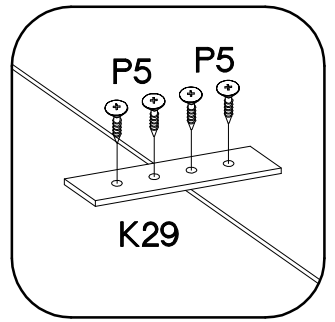
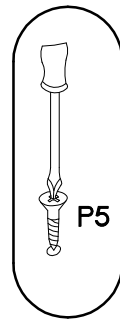

11

	±3.5x13mm
K29	P5
1	4



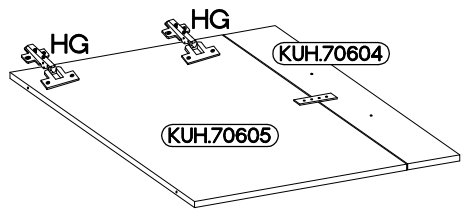
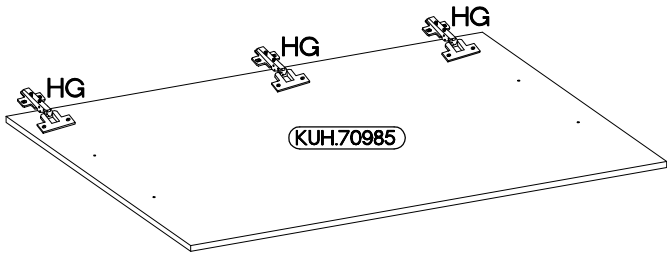
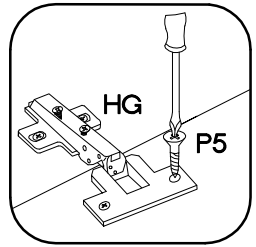
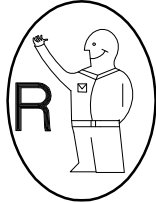

12

±35/0mm	±3.5x13mm
	
HG	P5
5	10

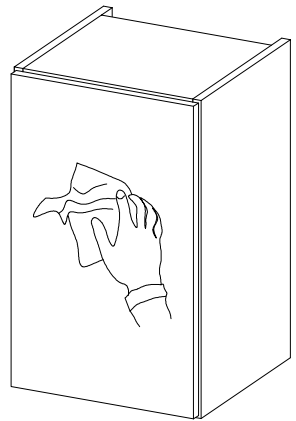
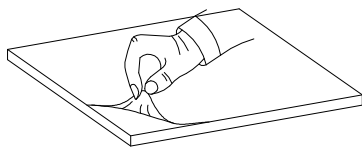
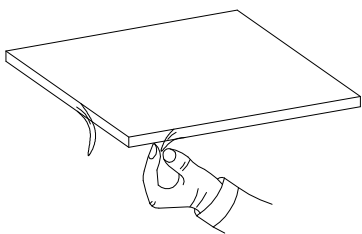

VARIANT HIGH GLOSS

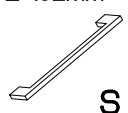



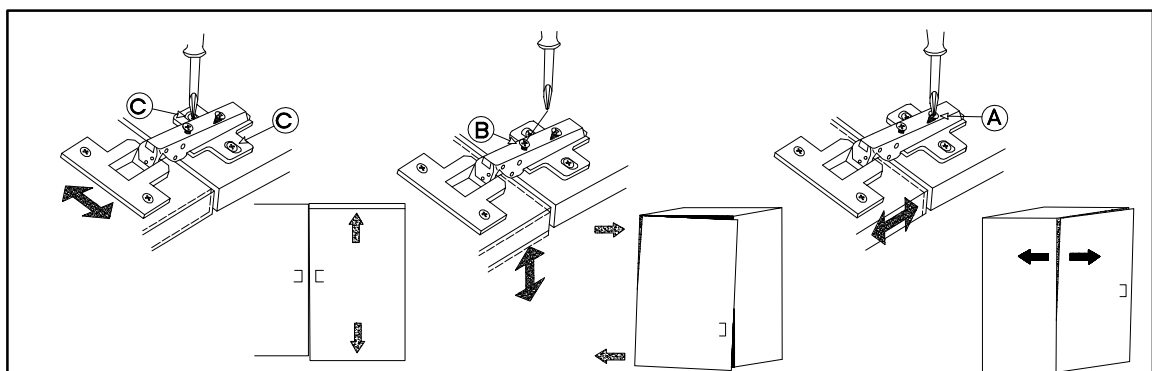
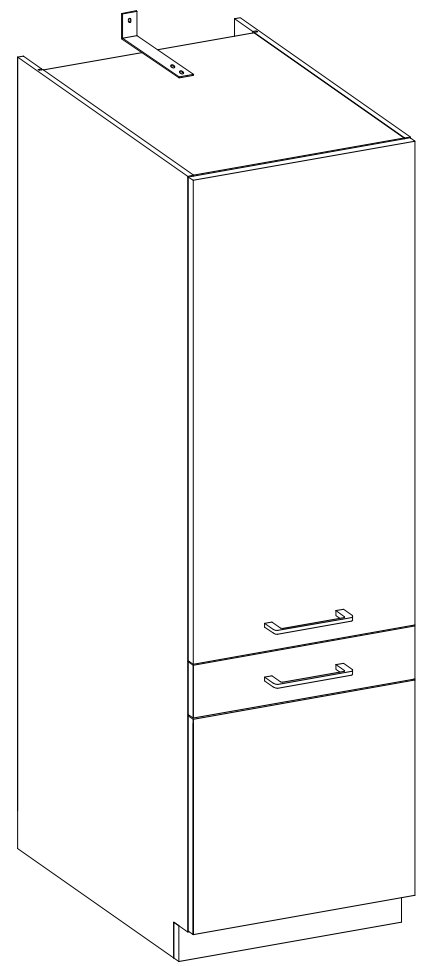
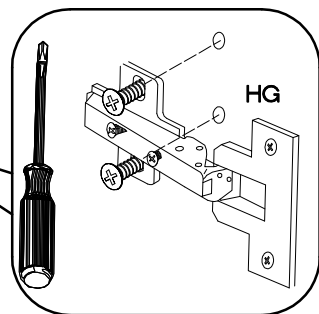
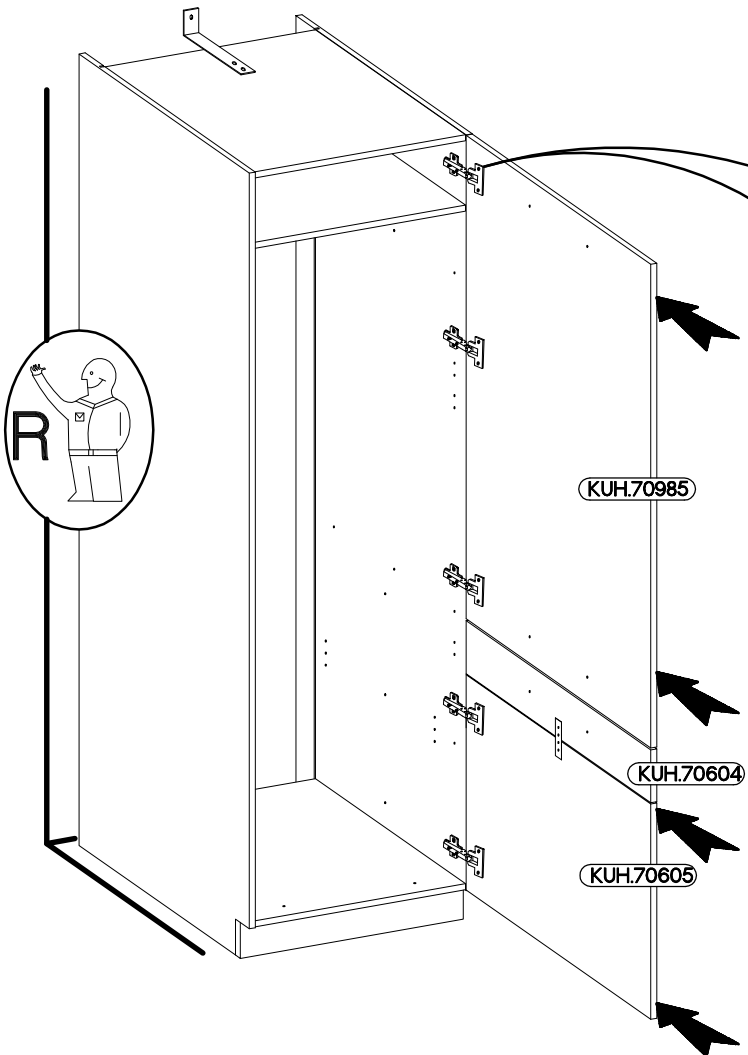
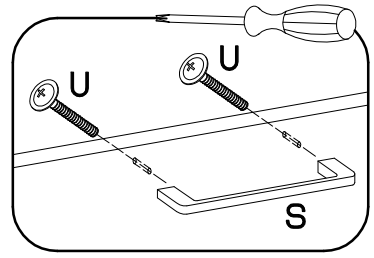

L=192mm	M4x22mm
	
S	U
2	4

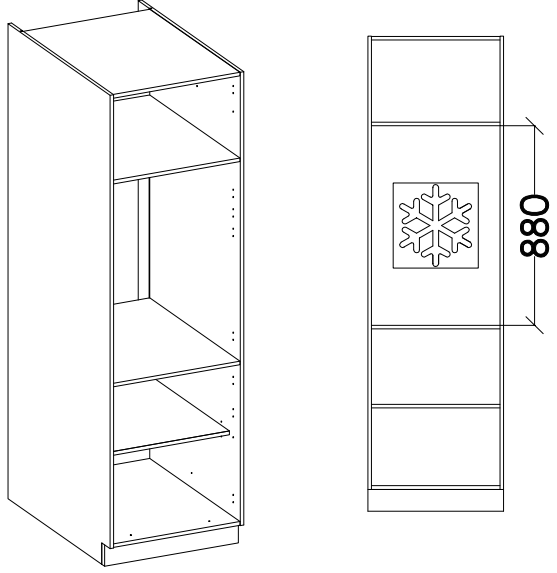

WARIANT B

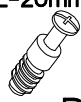

$\varnothing 8 \times 30 \text{mm}$  A	$6.5 \times 48 \times 16$  F2
8 L=20mm  D2	4 $\varnothing 15 / 12 \text{mm}$  C
12	12

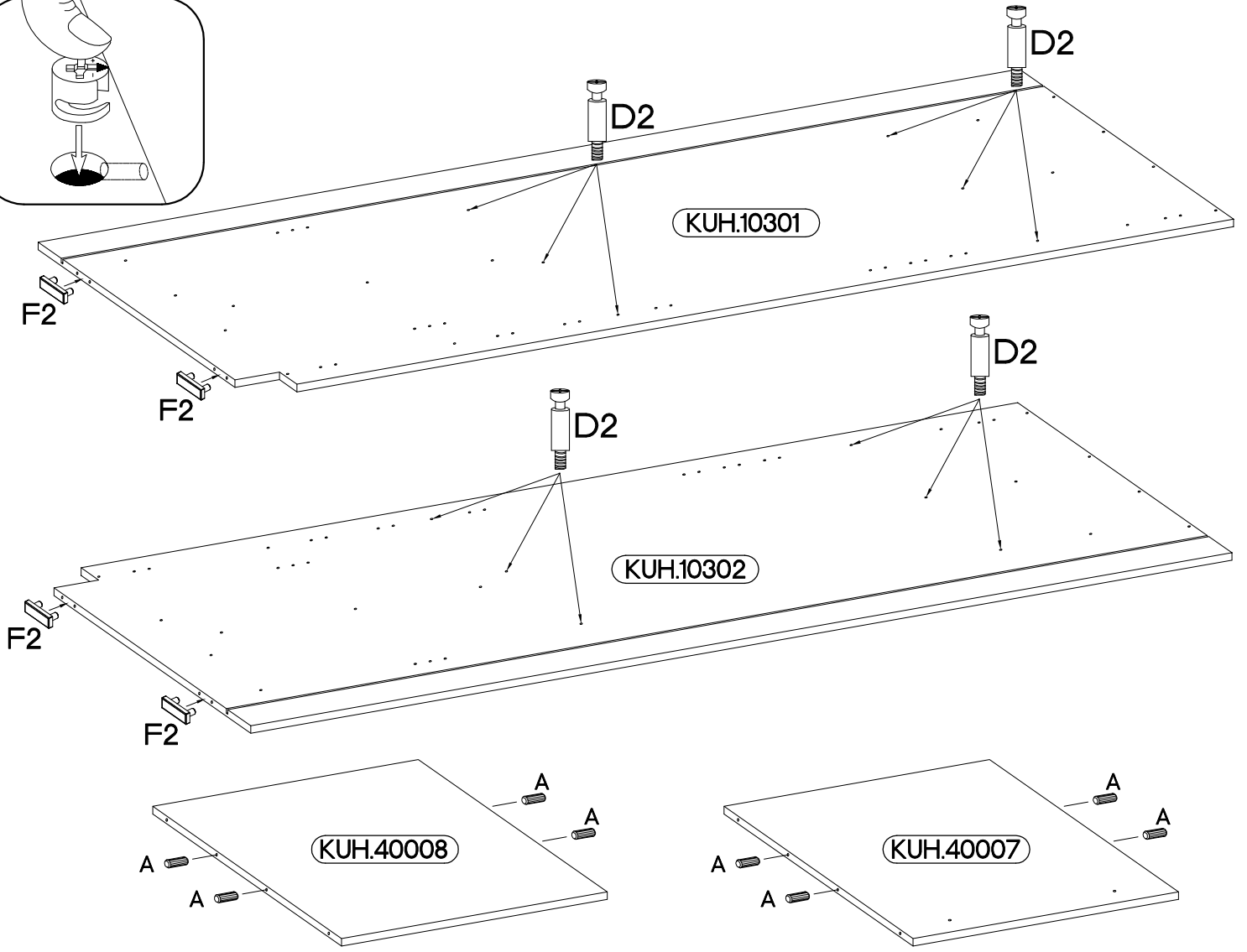
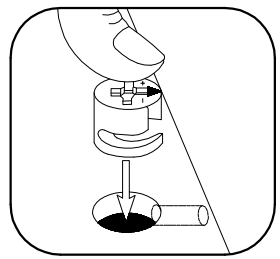
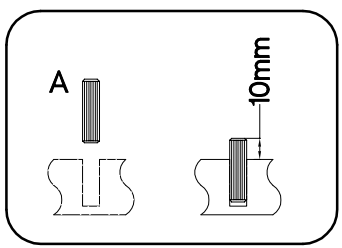
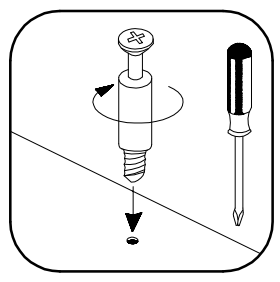
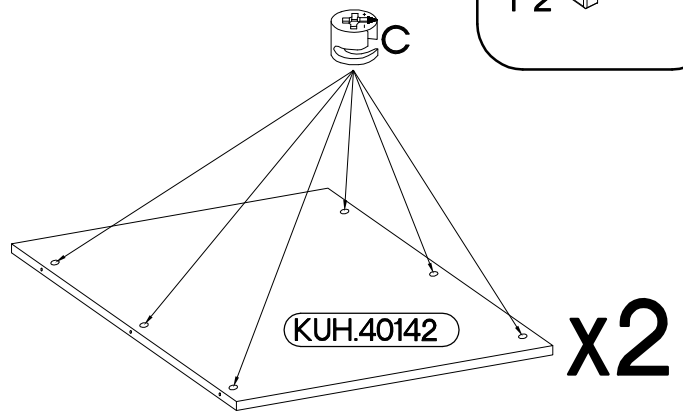
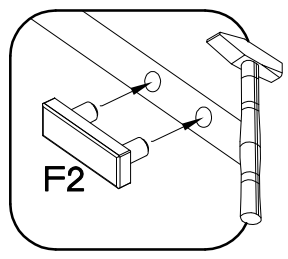
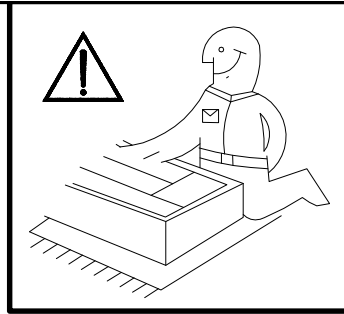

15

6,4 x 50mm

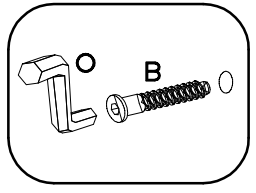
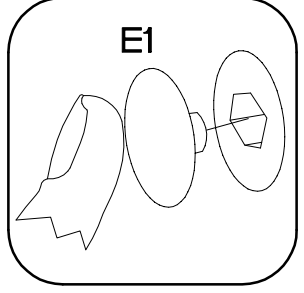
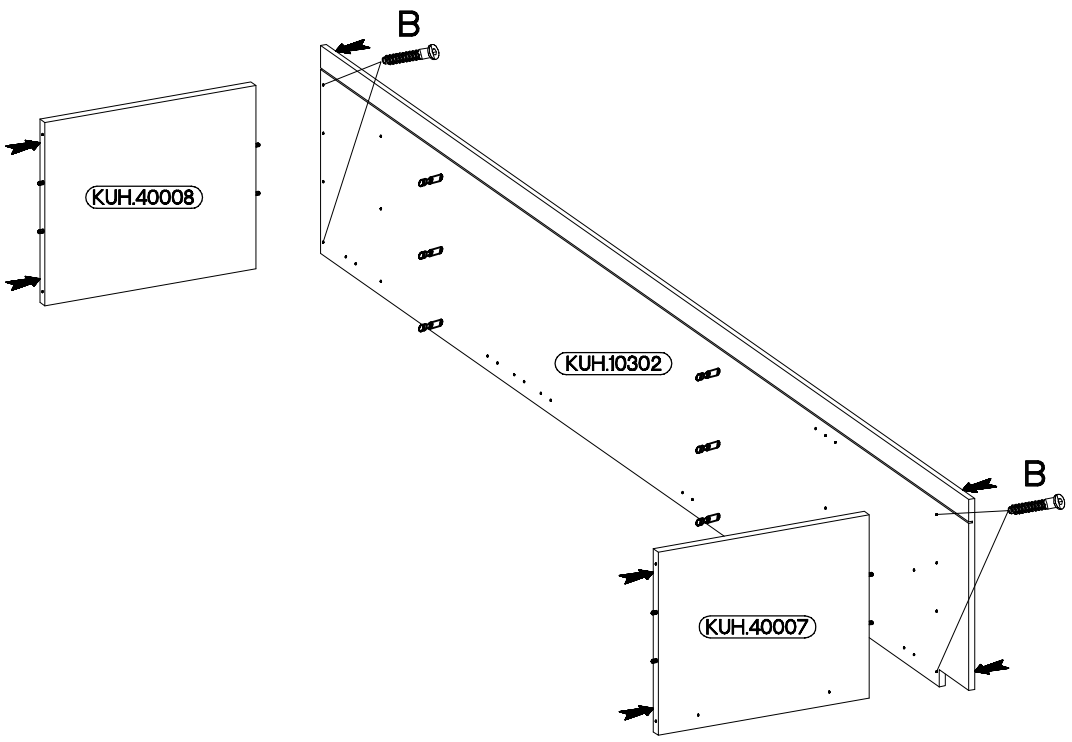
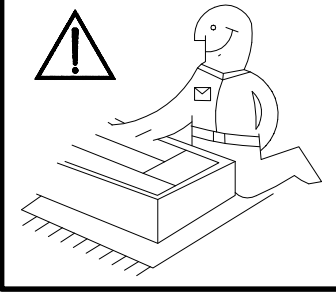
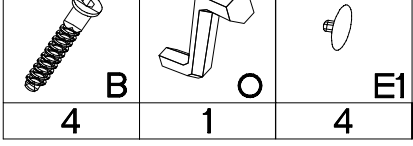

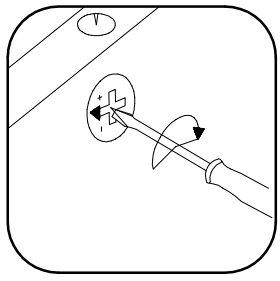
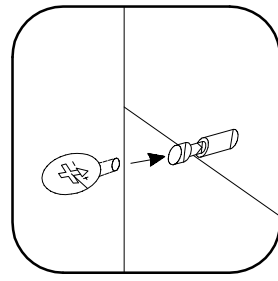
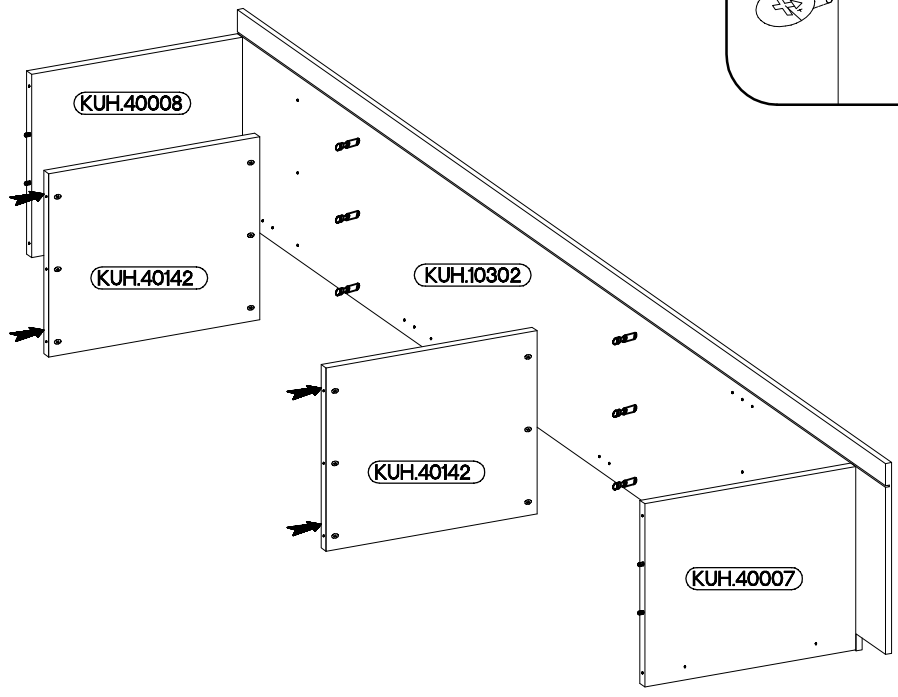

16



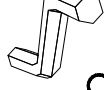

17

6,4 x 50mm

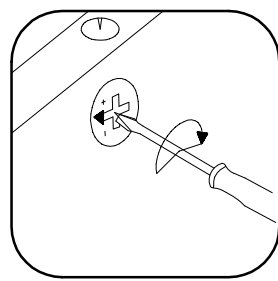
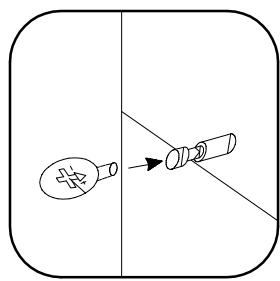
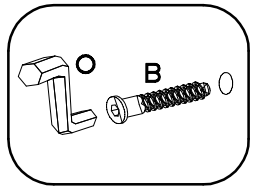
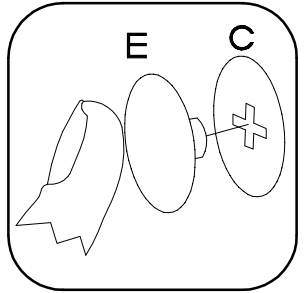
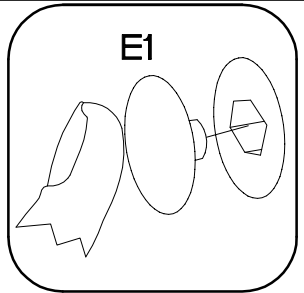
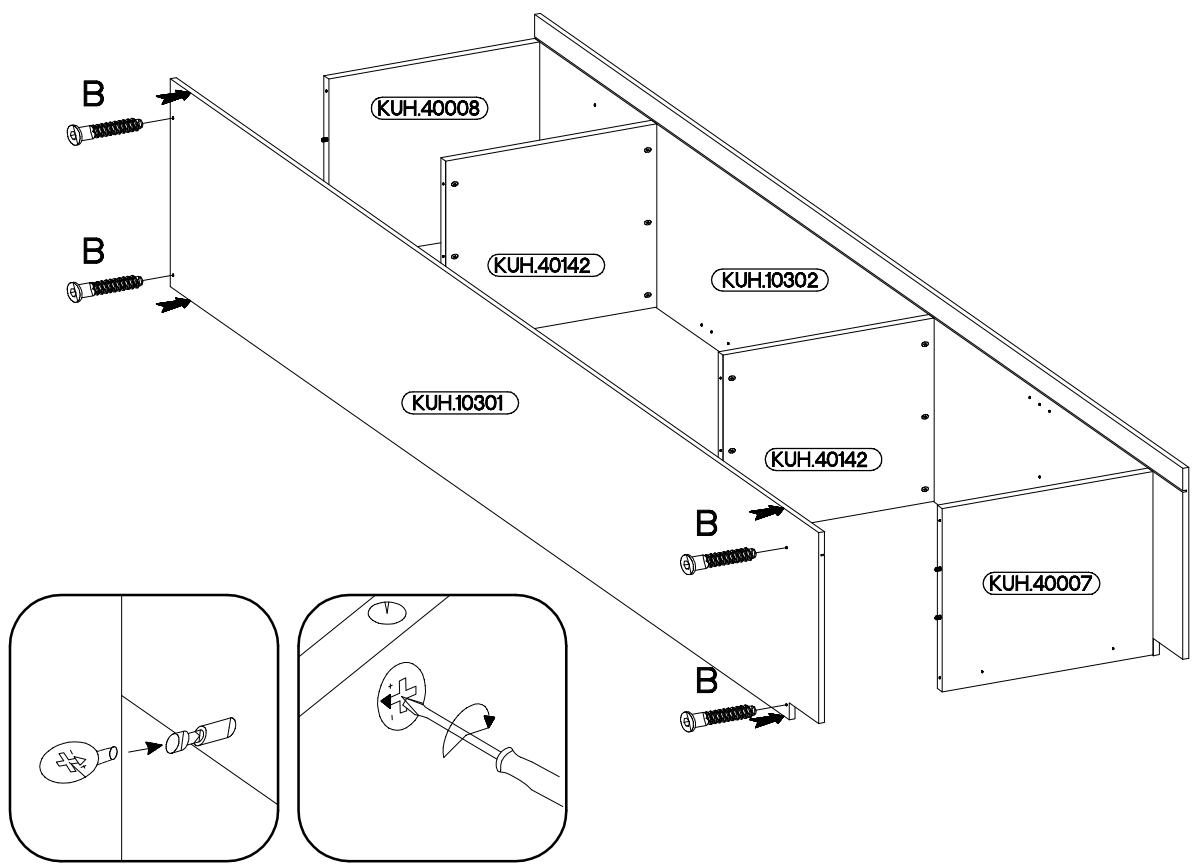
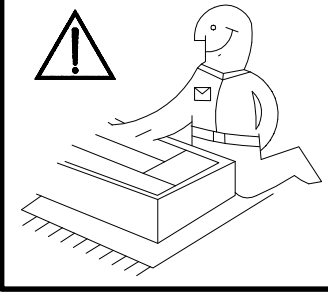
			
B	O	E1	E
4	1	4	12

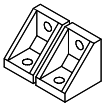

18

	
T4	P1
4	16

4.0x16mm

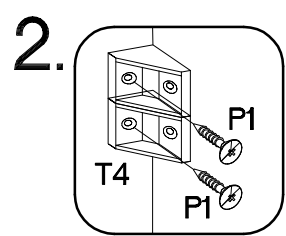
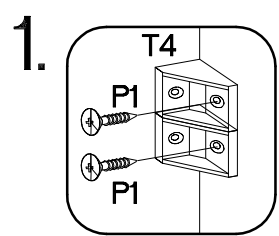
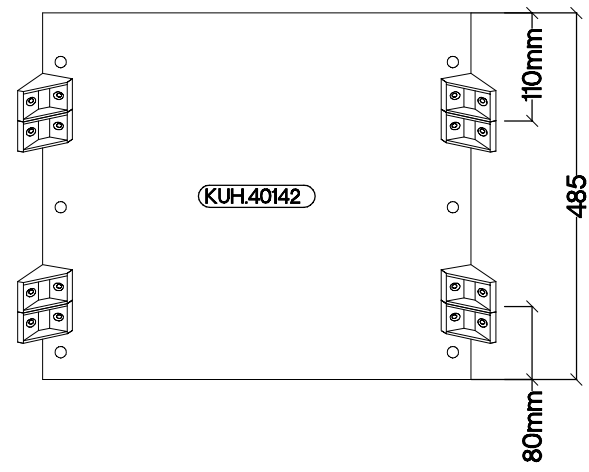
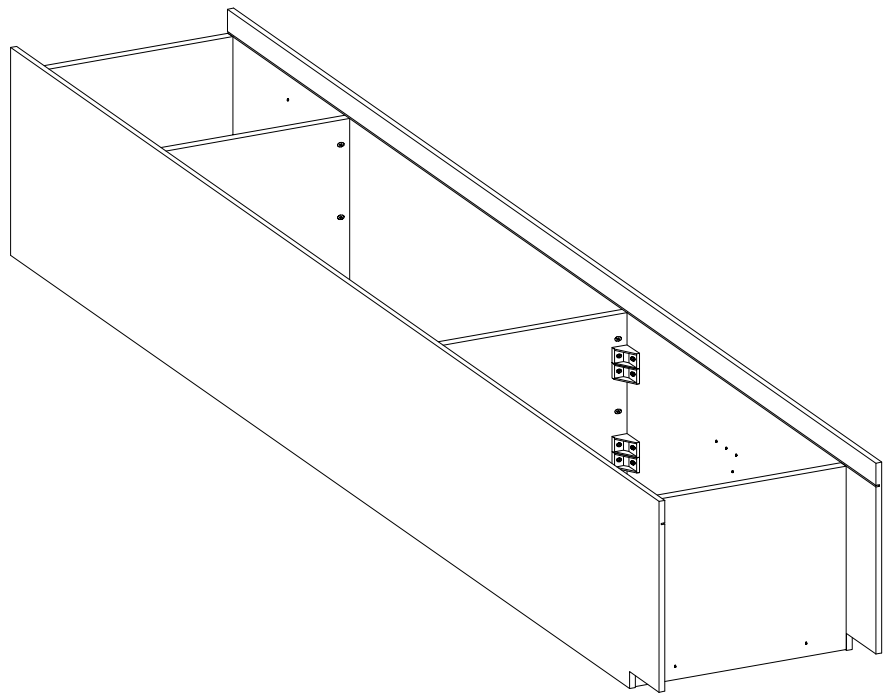

Ø3.0x20mm
P7
15-20

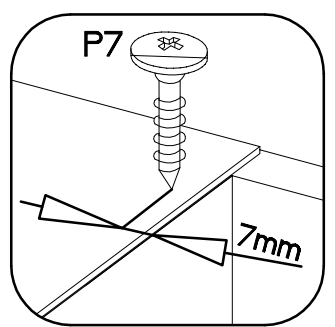
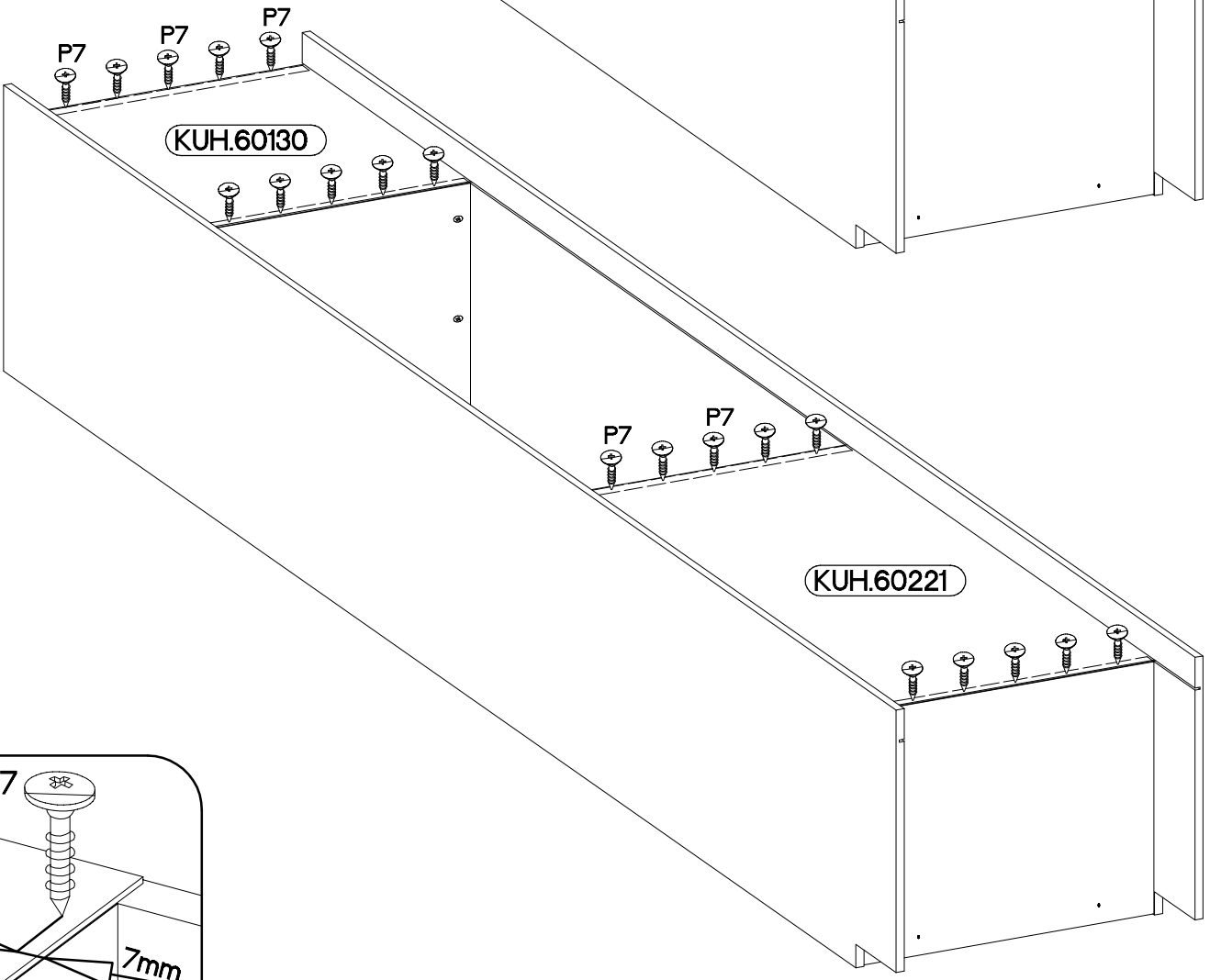
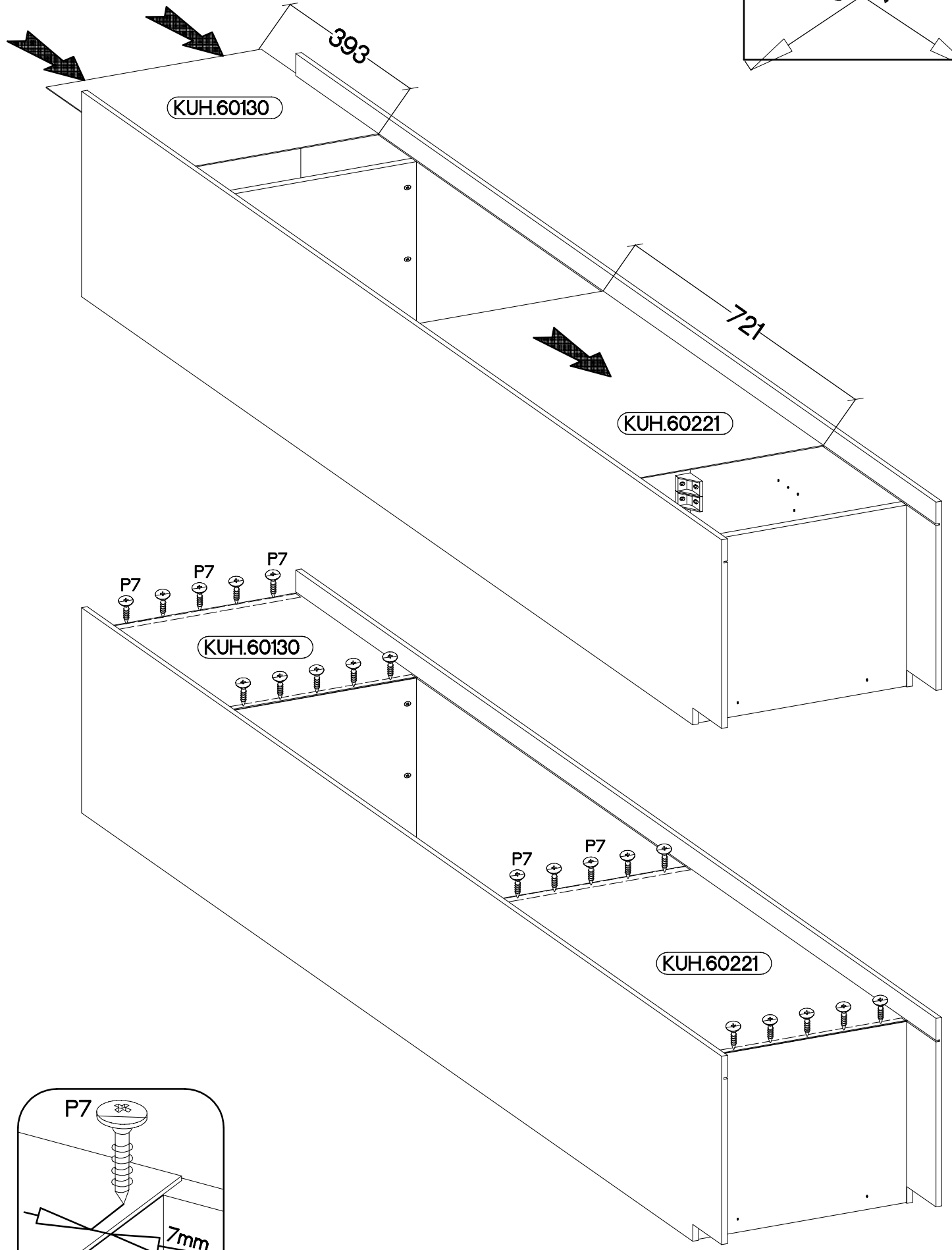
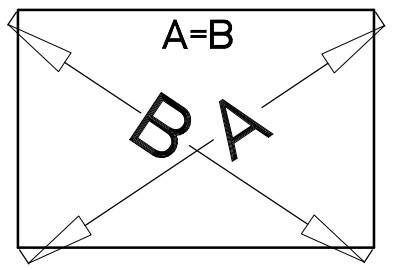

20

±4.0x45mm



P4

2



E9

2

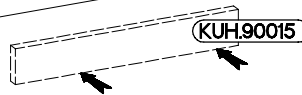
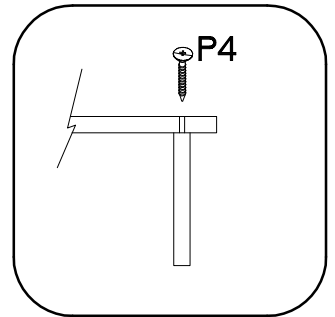
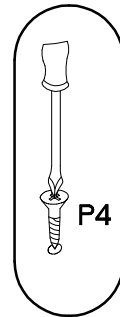
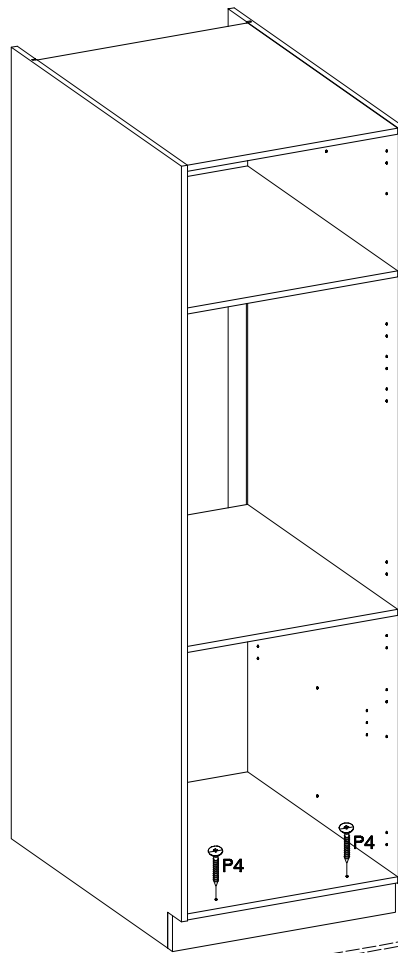

21

±5/19mm



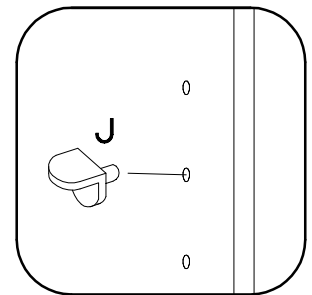
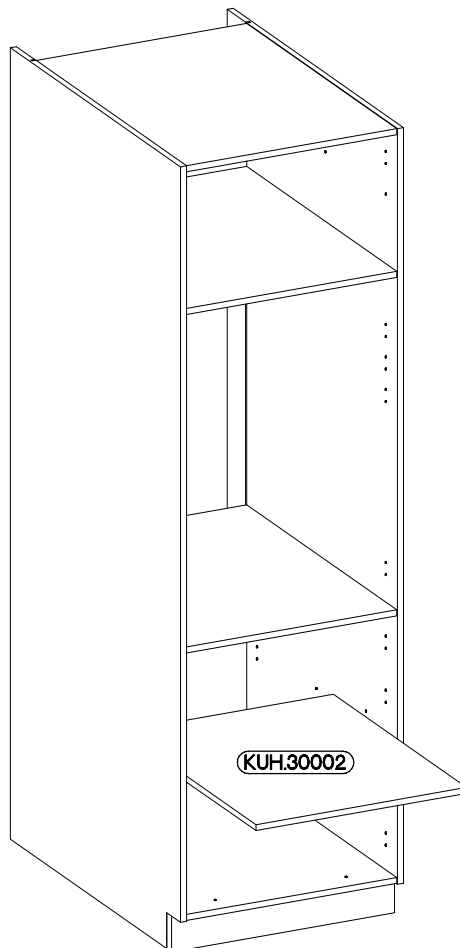

J

4

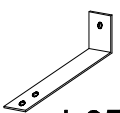

KUH.30002

 L25 1	 +3.5x13mm P5 2
--	--

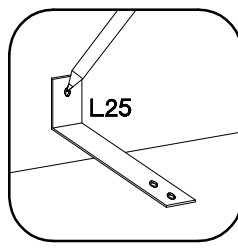
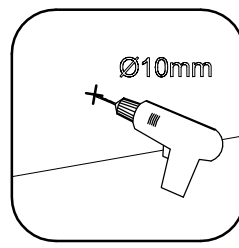
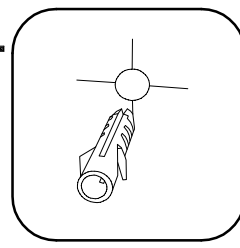
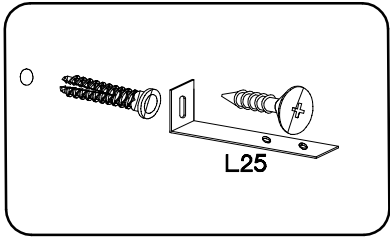
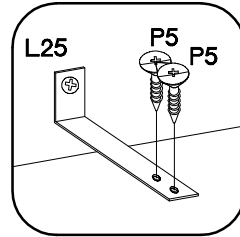
- 
- 
- 
- 
- 

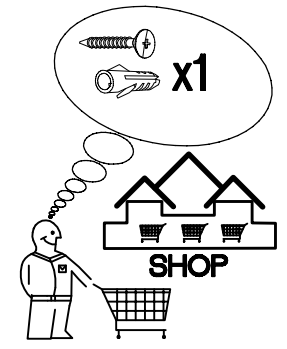
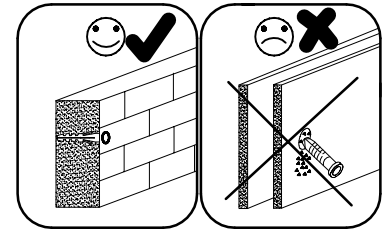
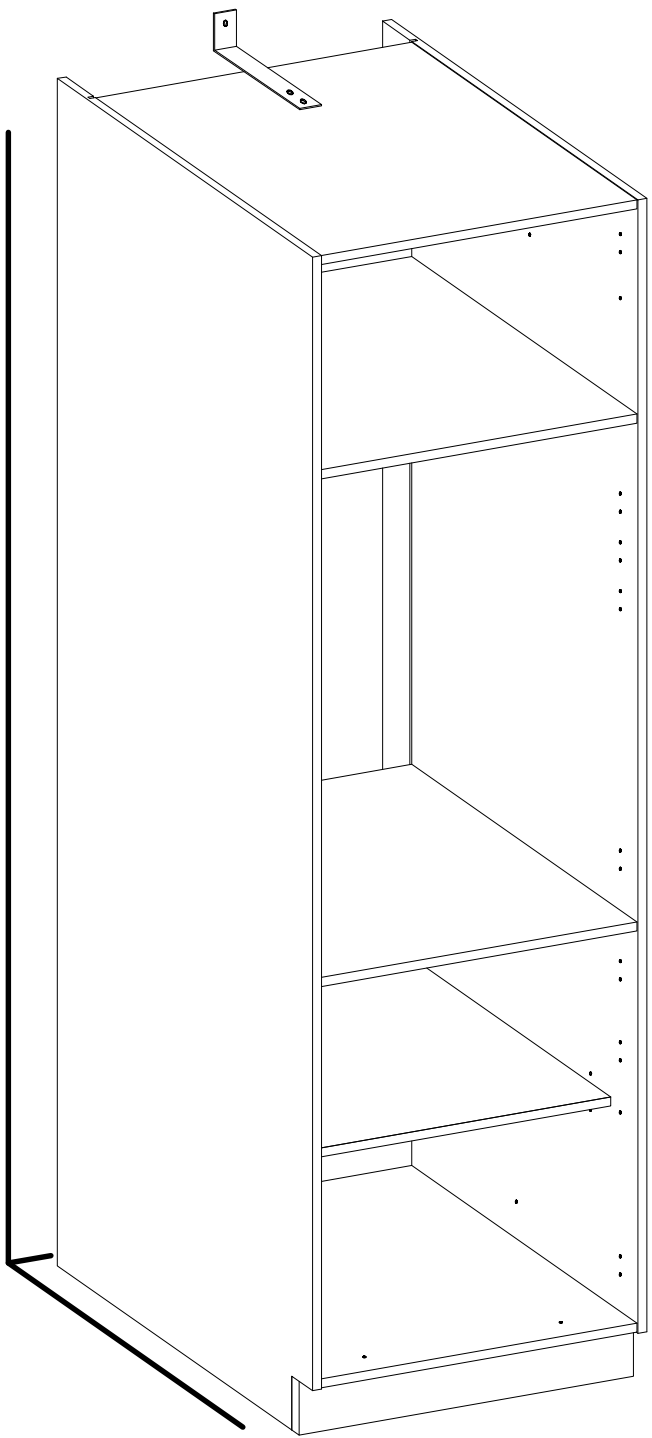

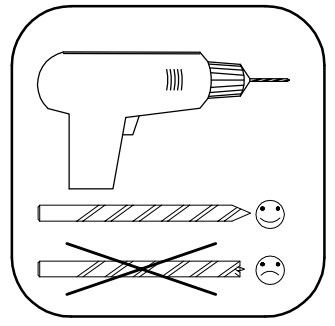
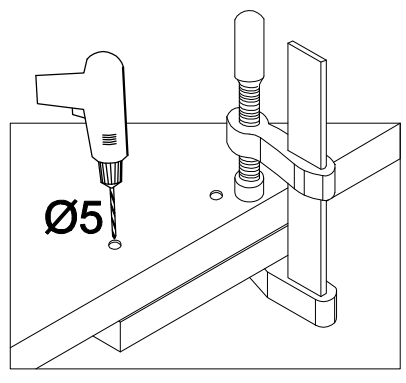
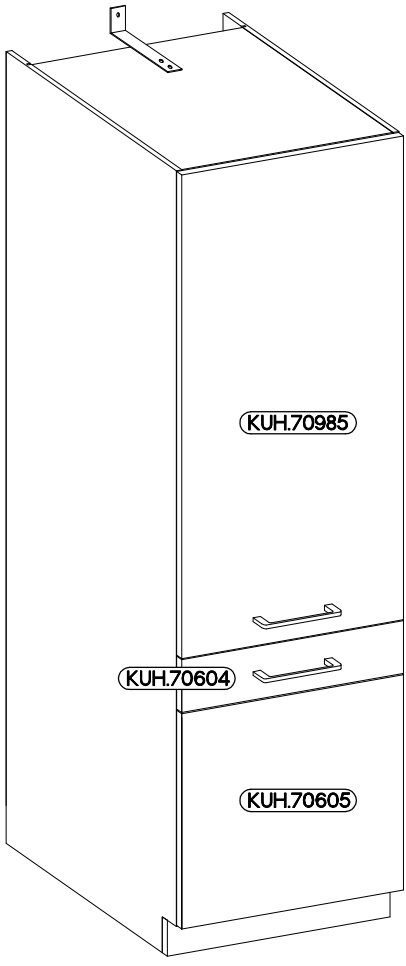

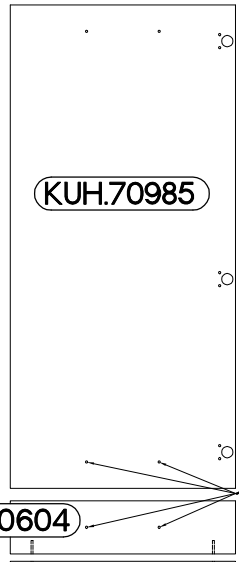
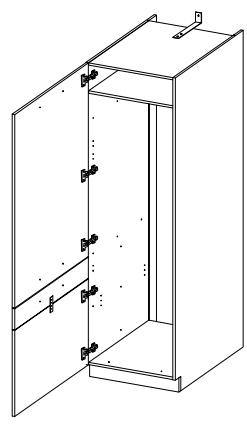

LEFT

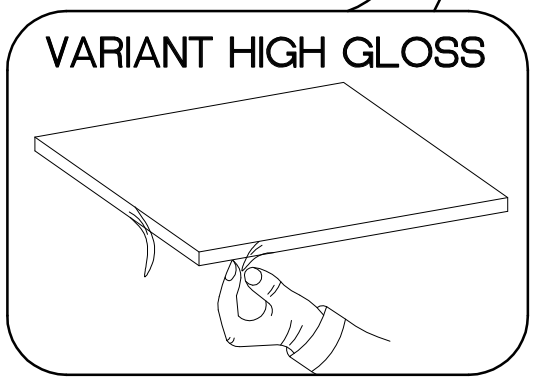
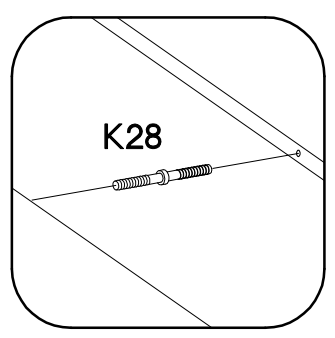
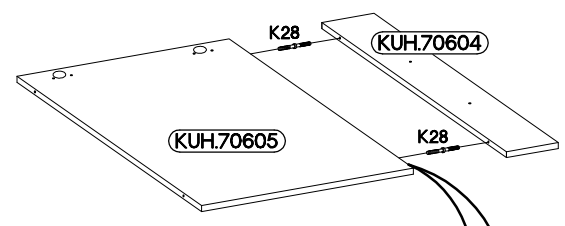
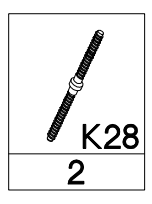
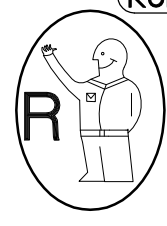
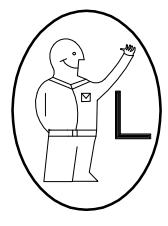
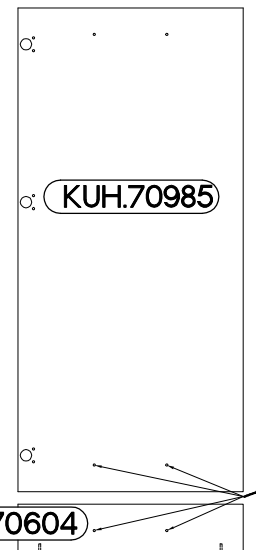
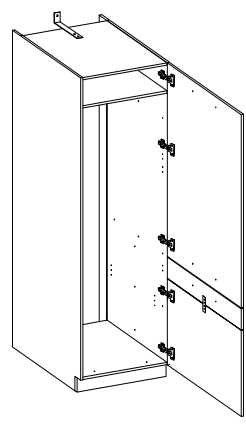

RIGHT



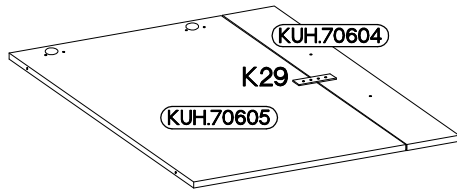
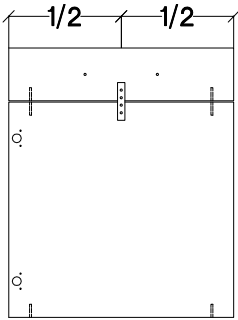
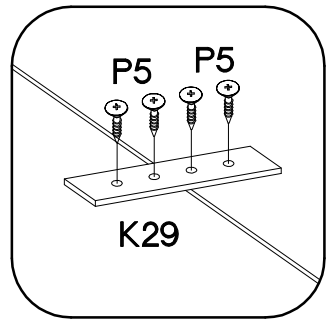
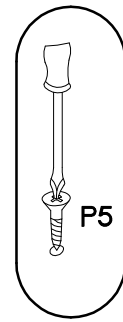

25

	±3.5x13mm 
K29	P5
1	4



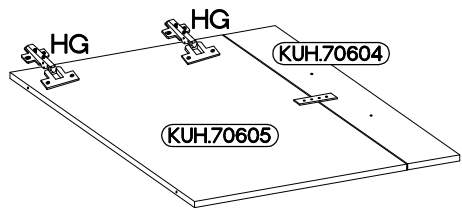
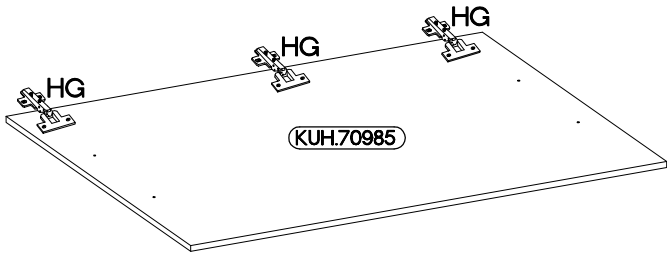
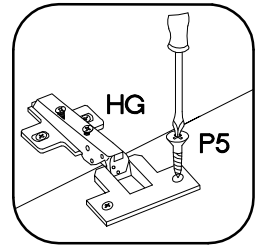
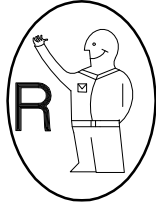

26

±35/0mm 	±3.5x13mm 
HG	P5
5	10

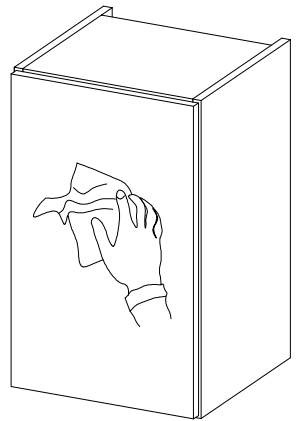
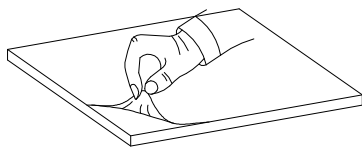
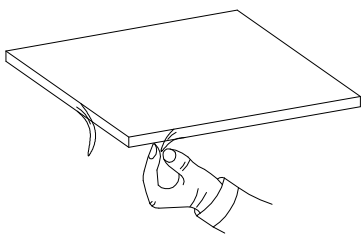

VARIANT HIGH GLOSS

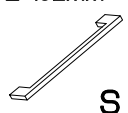

L=192mm	M4x22mm
	
S	U
2	4

